



GERBER

www.gerberonline.com

Maxwell® 1.6 GPF Elongated Toilet

10" Rough-in

Features:

□ MX-21-410

- Vitreous china
- Combination bowl and tank
- 3" Flush valve
- 10" Rough-in
- Elongated bowl
- Dual-fed siphon jet action bowl (no splashing)
- 2" Fully Glazed trapway for effective waste removal
- Color matched metal tank lever
- 6 point tank to bowl connection for tank stability
- Sanitary bead for easy cleaning
- Color matched Bolt caps included
- Toilet seat not included



Technical Information:

Included Components:

- Combination MX-21-410
- Bowl 21-962
- Tank MX-28-995

Fixtures:

Configuration	Two-piece, elongated
Water per Flush	1.6 gpf (6 lpf)
Rough-In	10"
Height	28 1/4"
Width	17 1/4"
Depth	27 1/8"
Trapway	2"
Large Water Surface	10 7/8" x 7 1/2"
Shipping Weight	73 lbs

Accessories:

Soft Close Toilet Seat	99-213
------------------------	--------

Colors/Finishes:

- White
- Other: Refer to Price Book for additional colors/finishes

Warranty:

- Limited lifetime warranty

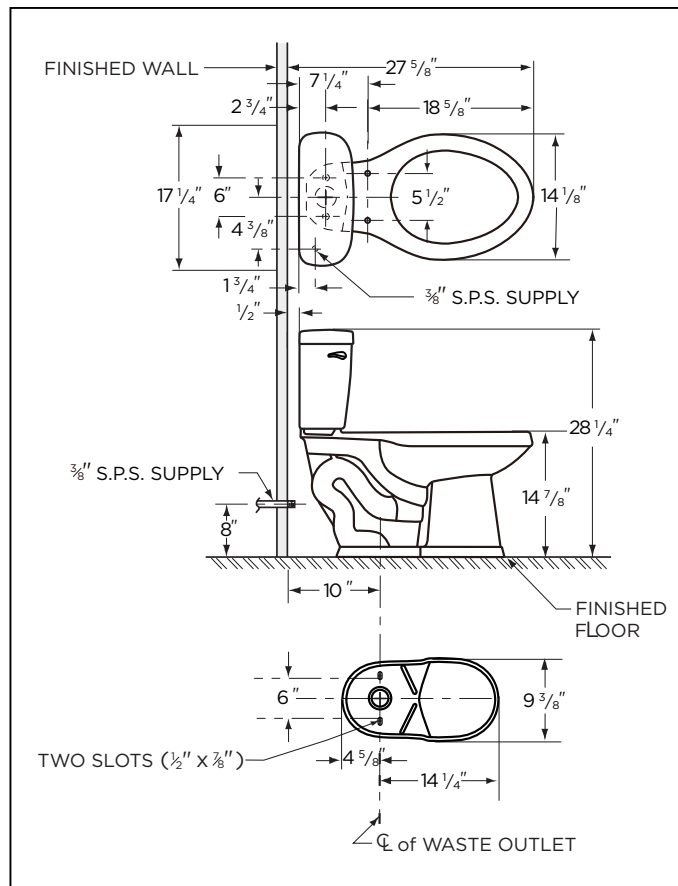

NOTES: All dimensions are in inches. Illustrations may not be drawn to scale.

IMPORTANT:

Dimensions of fixtures are nominal and may vary within the range of tolerances established by ASME standard A 112.19.2 THIS FIXTURE QUALIFIES ACCORDING TO ASME TEST PROCEDURES AS A HIGH EFFICIENCY WATER CLOSET WITH AN AVERAGE CONSUMPTION OF 1.28 gpf (4.8 Lpf) OR LESS.